

G-8149H-1L1C-T

Finezza Due Series

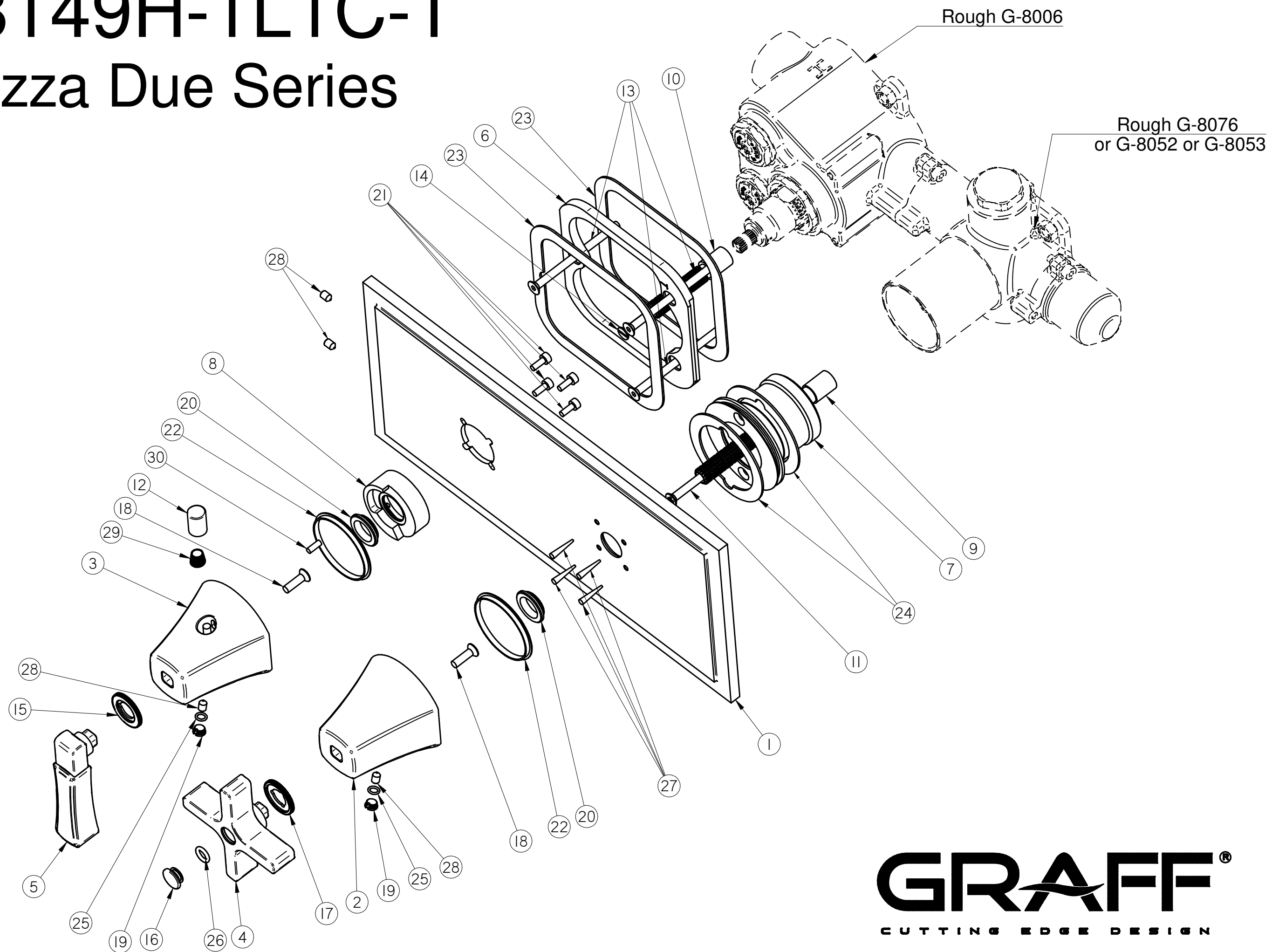

GRAFF[®]
CUTTING EDGE DESIGN